

汽车电阻(Automobile Resistor)DQTS

功率大，体积小，温度低，性能稳定，可满足定制日系、美系、德系等多款车型的汽车电阻

High Power, Small Size, Low Temperature, Stable Performance, customized models are available.



■ 结构 (Structure)

- 1.采用耐高温陶瓷作为电阻基体，具有较高的散热性。
Core Material: high temperature resistant ceramics, has good heat dissipation.
- 2.选用高稳定性的电阻合金丝，依严谨的工艺方法绕制并点焊在两个或多个导电端子上，使电阻具有较强的耐冲击性和较高的稳定性。不燃性涂漆包封，使电阻丝得到有效保护，从而提高其使用寿命。
High stable resistance alloy wire is wound on the core ceramic, wire ends are welded on conductive terminals, so that the resistor has strong impact resistance and high stability. Resistance wire is effectively protected with incombustible coating, service life is improved.
- 3.根据不同的车型和客户需要装配温度保险丝和塑胶底座组装成成品。
According to different vehicle models and customers' needs, temperature fuse and plastic base are assembled into finished products.

■ 特点(Features)

- 1.汽车调速电阻具有功率大，体积小，温度低，性能稳定等特点。
Automobile resistor has the characteristics of high power, small size, low temperature and stable performance.
- 2.单只电阻可以实现一个或二个或多个阻值。
Multi-resistance value can be achieved on one resistor.
- 3.电阻基体根据不同的车型和客户的要求，可以选择圆形、扁形或方形等不同外形，电阻扁丝或圆丝也可以波纹绕制。
According to different vehicle models and customer requirements, resistor core can be round, flat or square, and resistance wire can be strip or round wire, corrugated wound type is available.
- 4.可以依客户要求安装和装配开模订制，有多种颜色。
It can be assembled according to customer's requirements, customized models and colors are available.
- 5.也可依客户配备不同温度，不同要求的温度保险丝。
Temperature fuses with different temperature and different requirements can also be provided according to customers.

■ 适用范围 (Application)

深圳市正阳兴电子的系列汽车电阻生产周期为3-4周，生产全系列圆管陶瓷、扁陶瓷、方形陶瓷、铝管式、铝壳式等五十余款汽车空调电阻，用于日系、美系、德系等多款车型汽车调速电阻又被称为汽车电阻、汽车鼓风机电阻、汽车空调调速电阻等。常见阻值为R24, R25, R30, R35, R38, R69等多个阻值。
Lead Time: 3-4 weeks. Zenithsun produces a full range of automotive air conditioning resistors, which are used in many vehicle models such as Japanese, American and German. Automobile speed regulation resistor is also known as automobile resistor, automobile blower resistor, automobile air conditioning speed regulation resistor, etc. Common resistance values are R24, R25, R30, R35, R38, R69 and other resistance values.

■ 产品尺寸图表 以R30为例 (Dimension Chart, R30 as example)

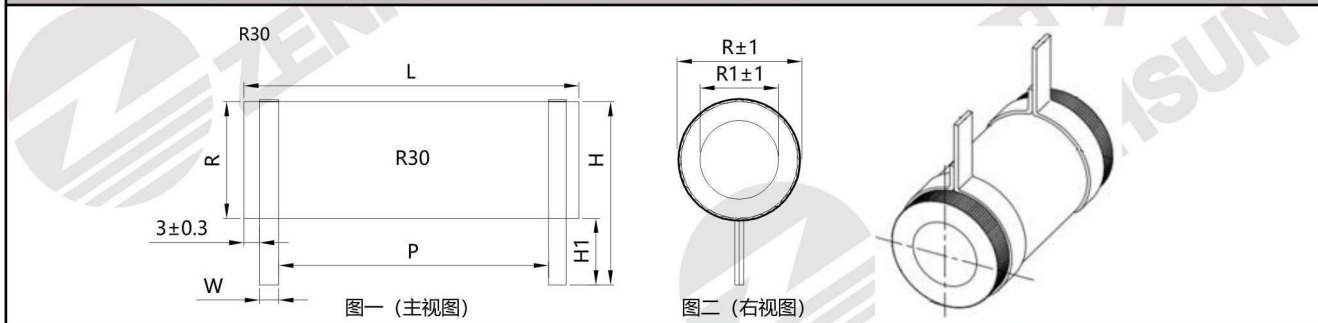

特性参数 Specifications				尺寸 Dimensions(mm)						备注 Note
最大功率 Pmax (W)	阻值范围 Ohms	电流 I (A)	最大电流 Imax (A)	L	M	H	W	R1	H1	P
63-115	0.3±10%	6-15	25-40	39.5-42	19.5-22	30-33	4-5	12-14	12-14	24-25

- 1.电阻基体根据不同的车型和客户的要求，可以选择圆形、扁形或方形等不同外形，电阻绕线丝可以选择扁丝或圆丝，也可以波纹绕制。
According to different vehicle models and customer requirements, resistor core can be round, flat or square, and resistance wire can be strip or round wire, corrugated wound type is available.
- 2.可以依客户要求安装和装配塑胶底座，并可开模订制，有多种颜色。
It can be assembled according to customer's requirements, customized models and colors are available.
- 3.也可依客户配备不同温度，不同要求的温度保险丝。
Temperature fuses with different temperature and different requirements can also be provided according to customers.

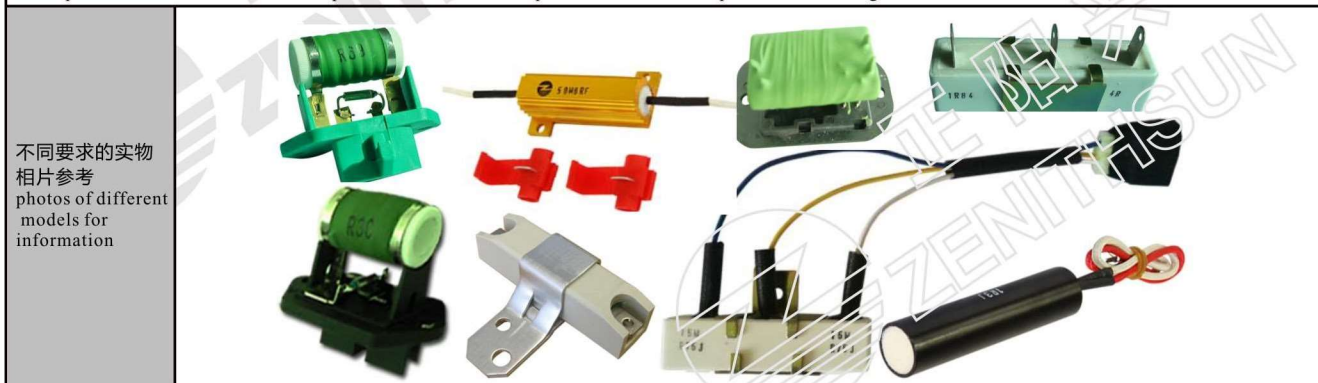

■ 汽车电阻性能实验参数 (Performance Characteristics)		
项目 Test	试验条件 Conditions of Test	性能要求 Testing Results
电阻值容许误差 Resistance Tolerance	测试电压≤3V,环境温度25°C Testing Voltage ≤3V, Ambient Temperature 25°C	J--K
温度系数 T.C.R	$\frac{R1-R0}{R0(T1-T0)} \times 10^6$ (PPM/°C) R0:常温(T0)下阻值 R0:Room Temperature(T0)Resistance R1:常温T0+100°C(T1)下阻值 R1:Room Temperature T0+100°C(T1)Resistance	±100PPM~ ±250PPM
额定负荷 Rated Load	40°C额定电压, 1小时 40°C, rated voltage, 1 hour	$\Delta R \leq \pm(1\%R + 0.1\Omega)$
短时间过负荷 Short Time Overload	5倍额定功率, 5秒钟 5 times rated power for 5s	$\Delta R \leq \pm(2\%R + 0.1\Omega)$
引出端对地绝缘耐压 Dielectric Withstand Voltage	1KVdc 60秒,漏电流2.5mA 1KVdc 60s, leakage current 2.5mA	$\Delta R \leq \pm(0.1\%R + 0.05\Omega)$
绝缘电阻值 Insulation Resistance	500VDC	≥100MΩ1Min
引出端强度 Terminal Tensile Strength	3Kg 30s	无脱落 No off
耐振性 Vibration resistance	1.5mm,10-55-10Hz, 分别2小时 1.5mm, 10-55-10Hz, each 2hours	无破损, 无脱落 No damage, No off
室温耐久性 Load Life	额定电压, 通电90分钟, 停30分钟, 共500小时 At rated voltage, 90 min "On", 30 min "Off", total 500hours	$\Delta R \leq \pm(5\%R + 0.1\Omega)$
热冲击 Thermal Shock	静置于30°C, 30分钟, -55°C, 15分钟 Standing at 30°C for 30 minutes, then standing at -55°C for 15 minutes	$\Delta R \leq \pm(2\%R + 0.1\Omega)$
耐湿性 Humidity	温度: 40±2°C 湿度: 90%-95%.240小时 Temp.: 40±2°C, RH: 90%-95%, 240 hours	$\Delta R \leq \pm(3\%R + 0.1\Omega)$
不燃性 Non-flammability	1-6倍额定功率, 通电5分钟 1-6 times rated power, power on for 5Min	允许开路, 但不燃烧 Without combustion

■ 汽车电阻降功耗曲线图 (Derating Curve)

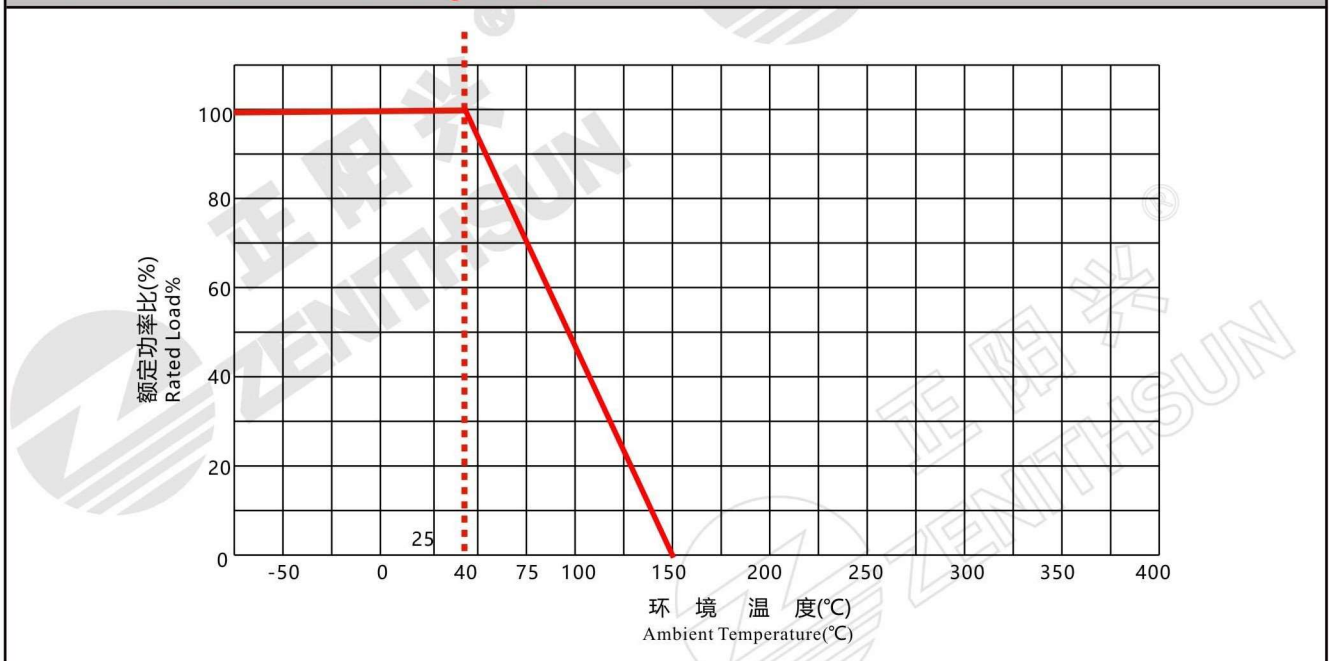

电阻产品体系图>>>

铝壳电阻ASZ



铝壳电阻ASCB



铝壳电阻RH/NH,ASC



高压电阻R180



电阻产品体系图>>>

厚膜电阻ZMP/RI82/RF82



水冷电阻SLR



绕线电阻DDR/DNR、DQR/DQN、DSR、DRBY/DSBY



滑动电阻DSY、DST、BC1

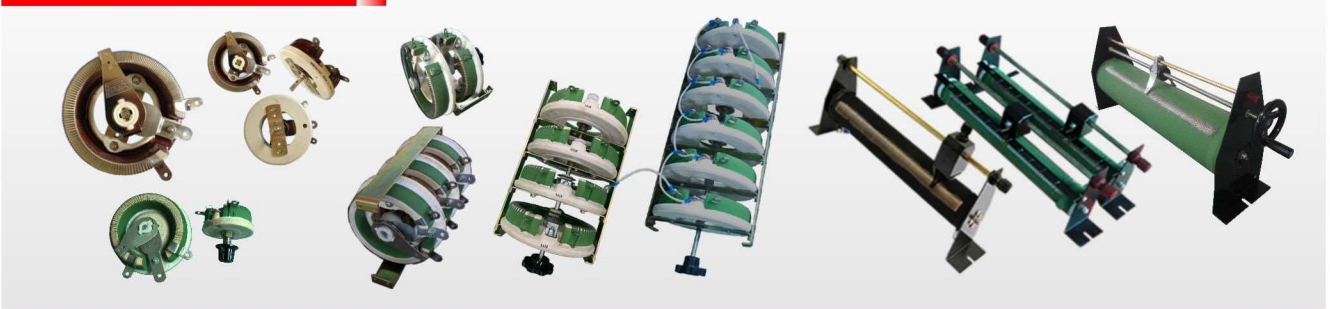

电阻产品体系图>>>

板型电阻ZB



高能电阻HD



汽车电阻DQTS/摩托车电阻TWS

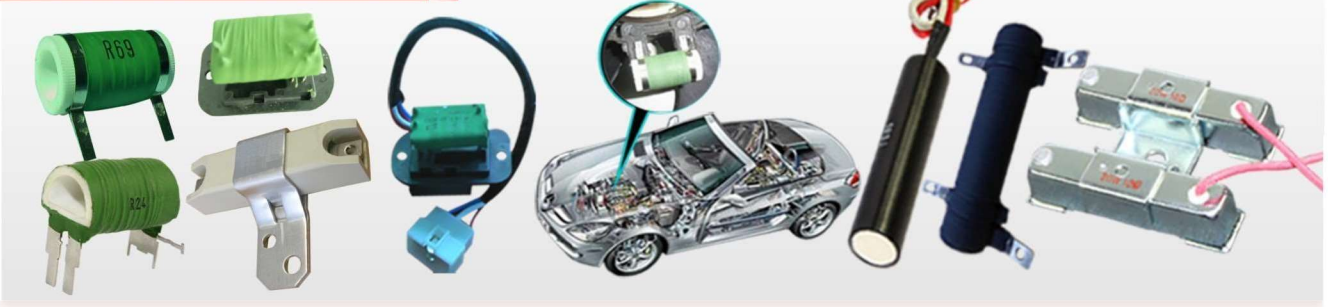

水泥电阻SR

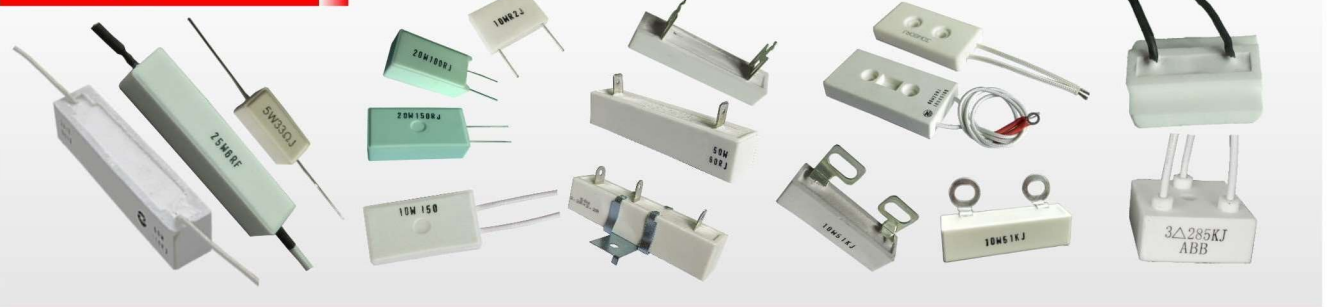

电阻产品体系图>>>

碳膜高压电阻PC/分流器FL/瓷棒绕线电阻KN

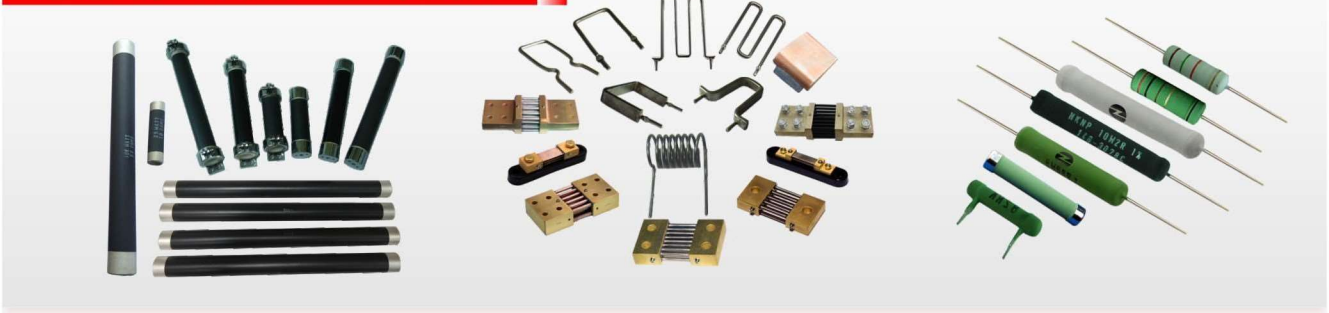

无极可调电阻箱DSYB、DSTB、BC1B



不锈钢电阻BXG



风冷阻负载DRLB/水冷负载SRLB

